



regione campania
aslnapoli3sud
Direttore Generale: Dott. G. Russo

*Piano Regionale di Prevenzione 2020 -2025
Linea Programmatica Prevenzione in
Edilizia ed Agricoltura - PP07*

Sbagliato – giusto: come comportarsi in cantiere

*Falsch – richtig: Wie verhält man sich auf der Baustelle
Faux – juste: comment se comporter sur les chantiers
Wrong – right: how to behave on construction sites
Mal – bien: cómo comportarse en las obras*

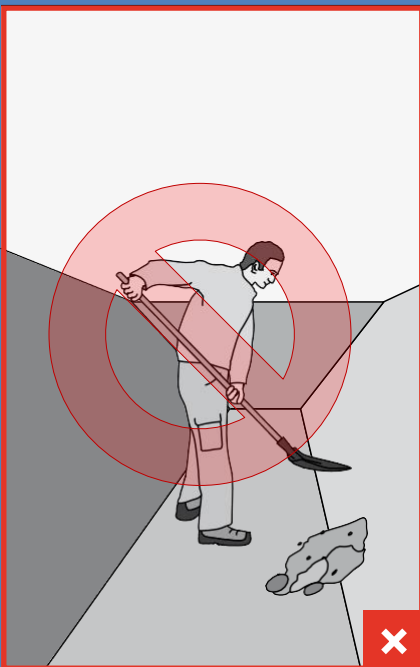
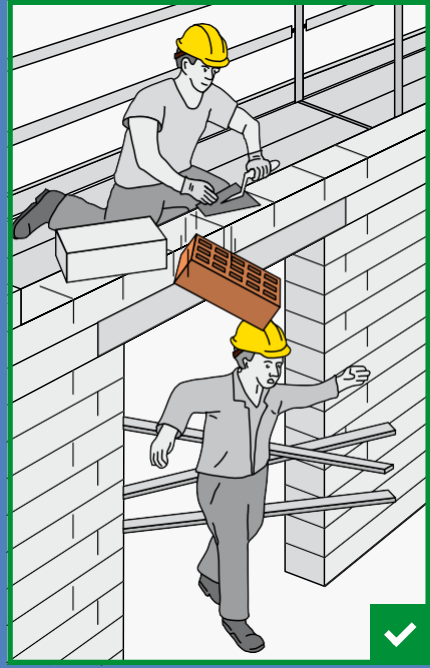

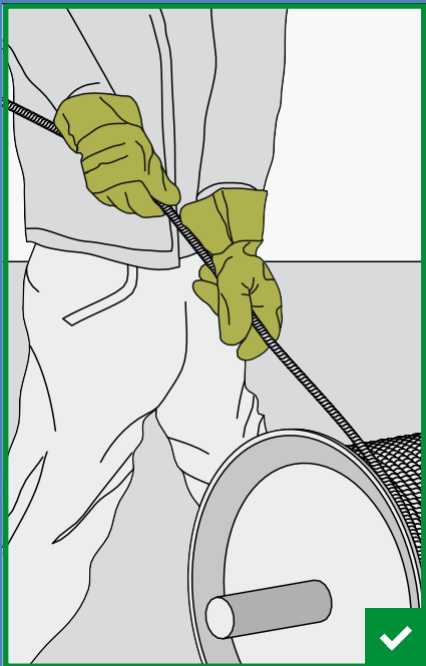
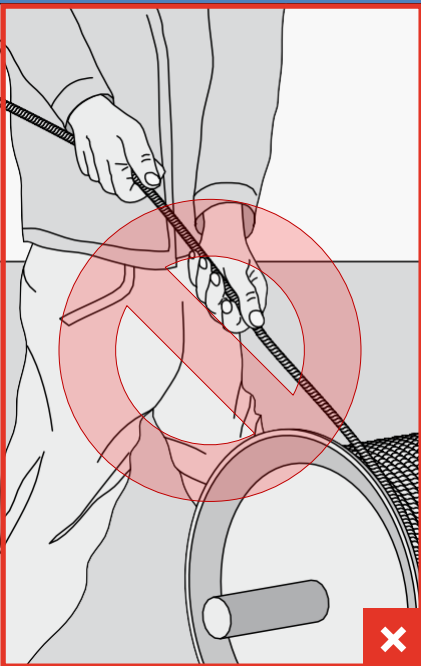
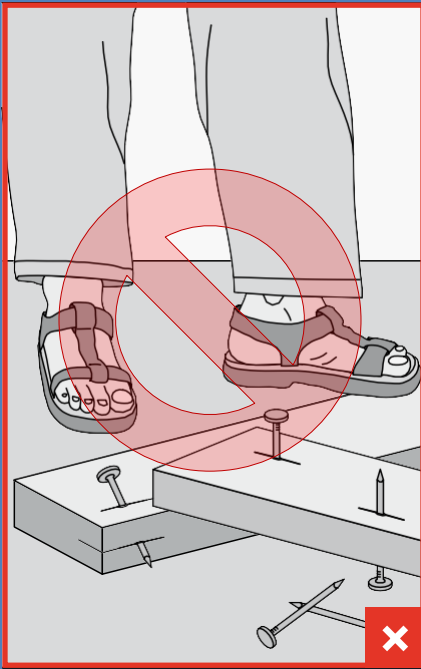

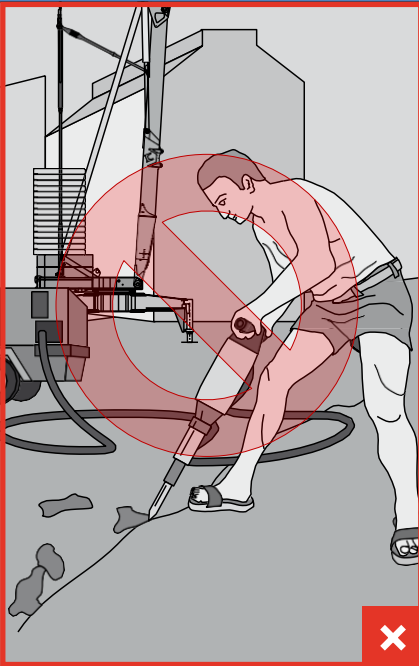
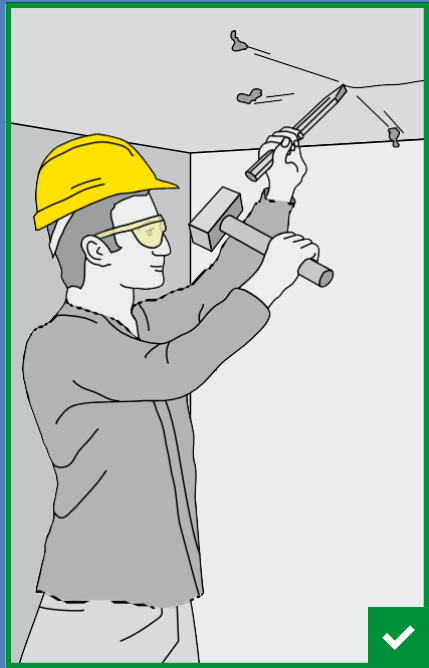
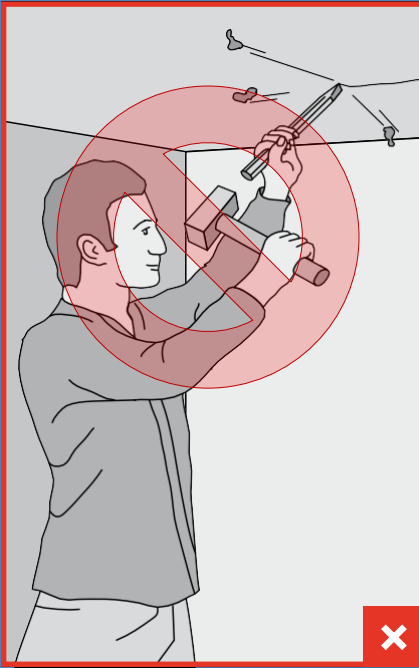

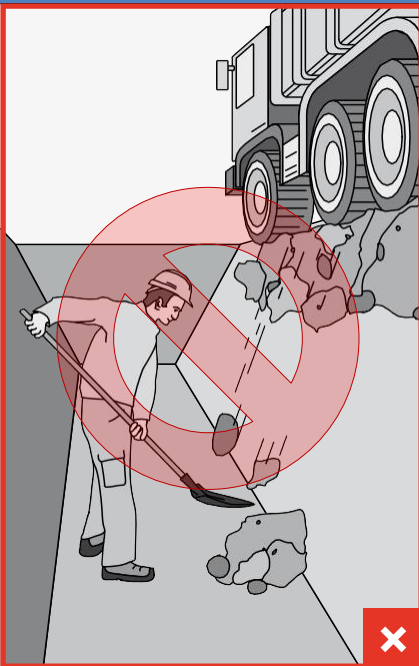
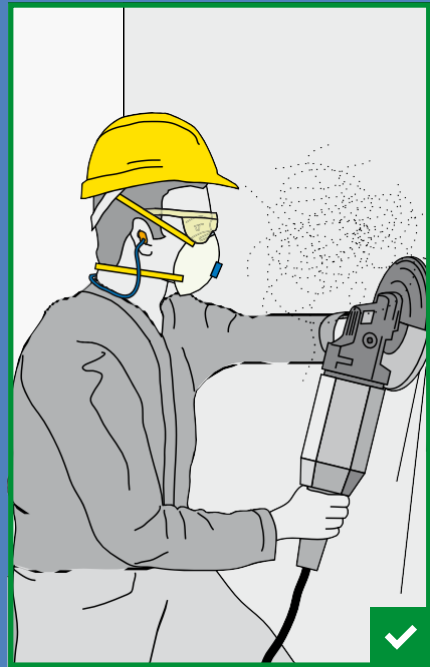

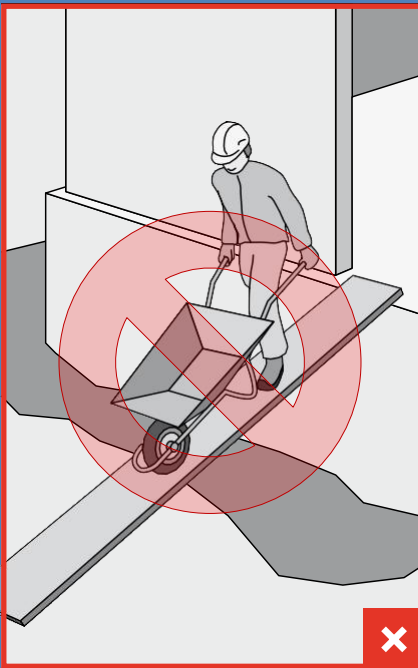
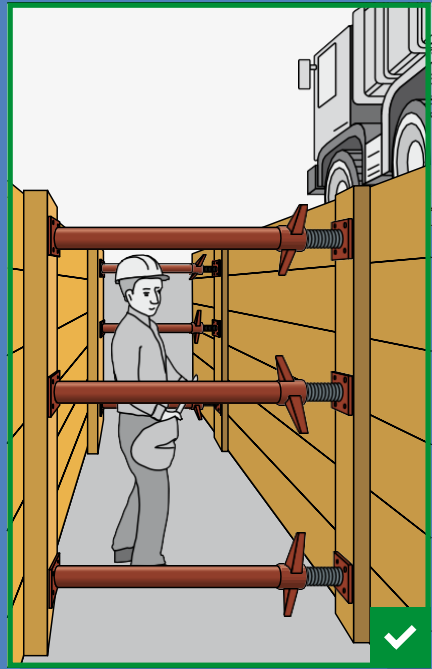
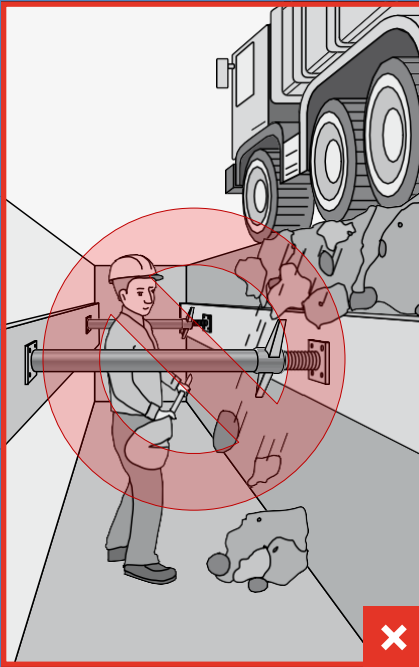

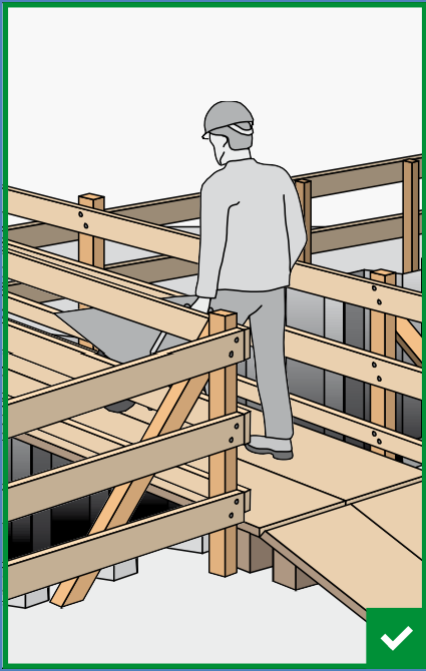
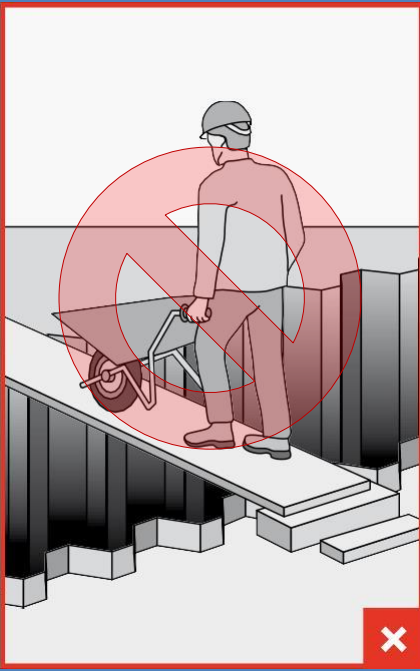

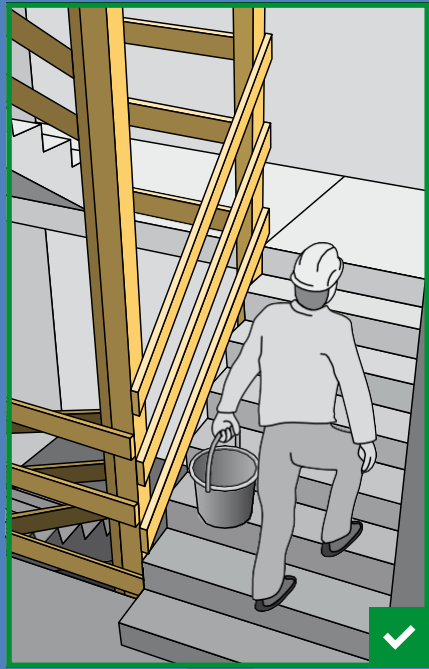
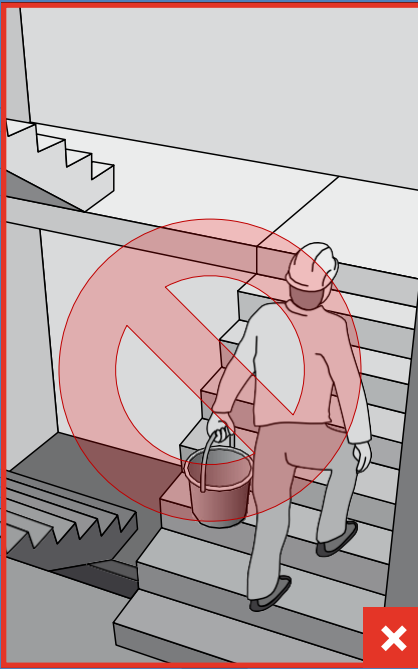

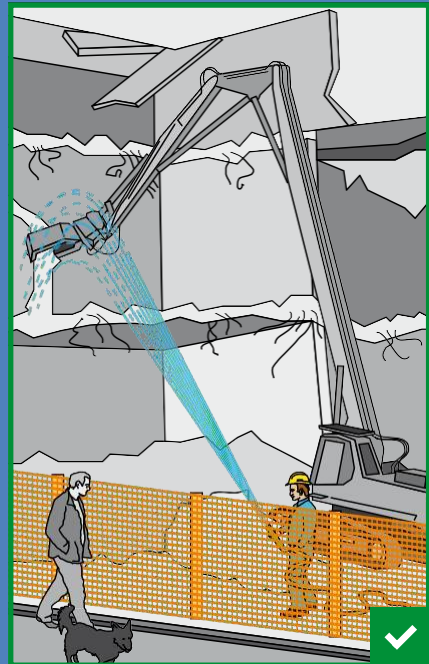
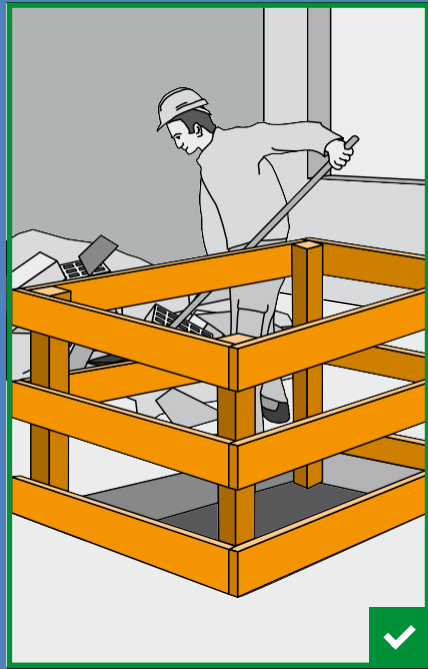
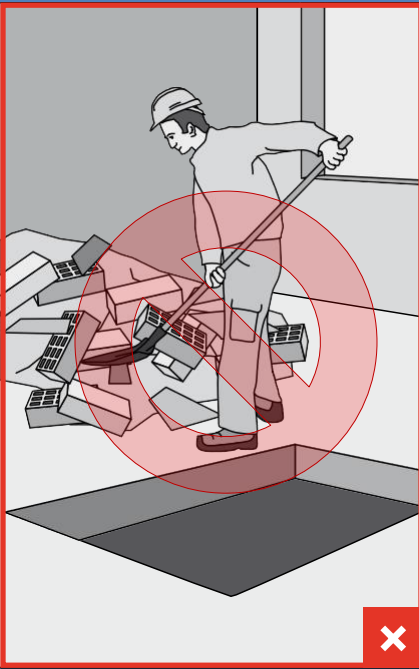

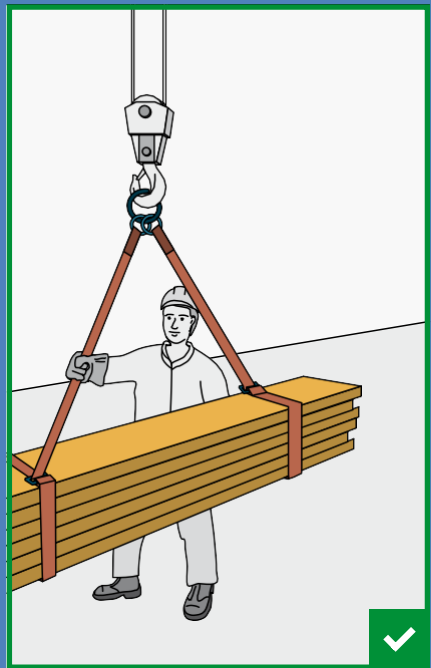
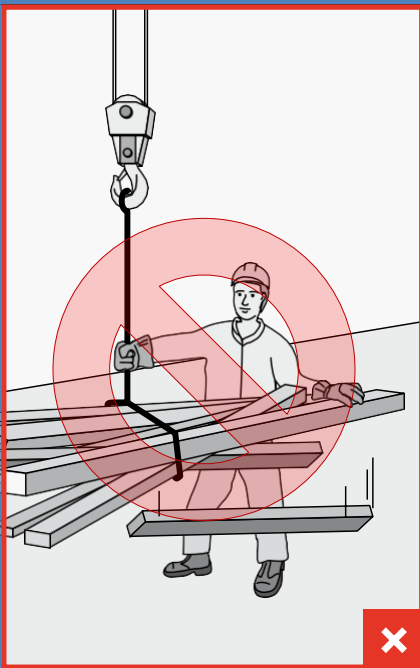
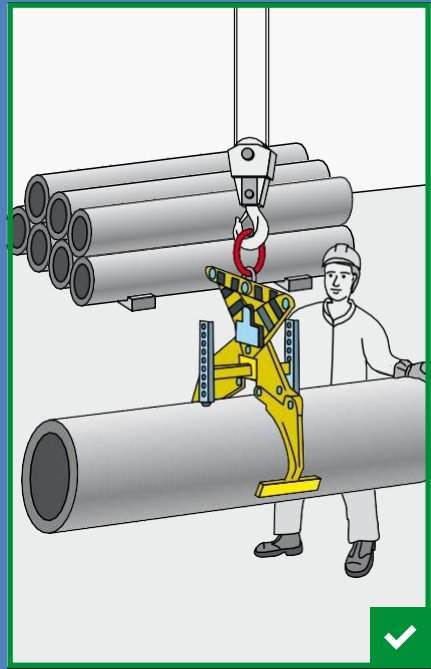
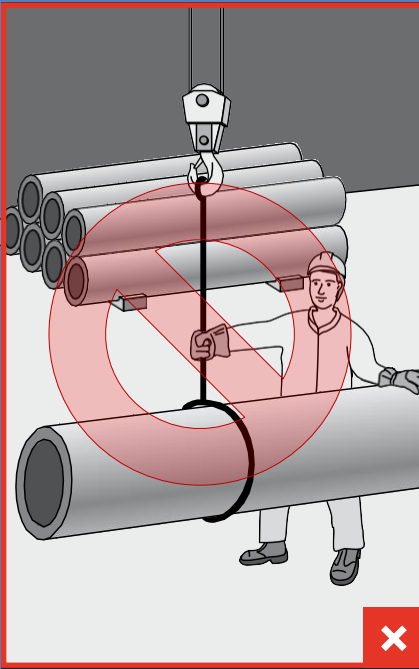

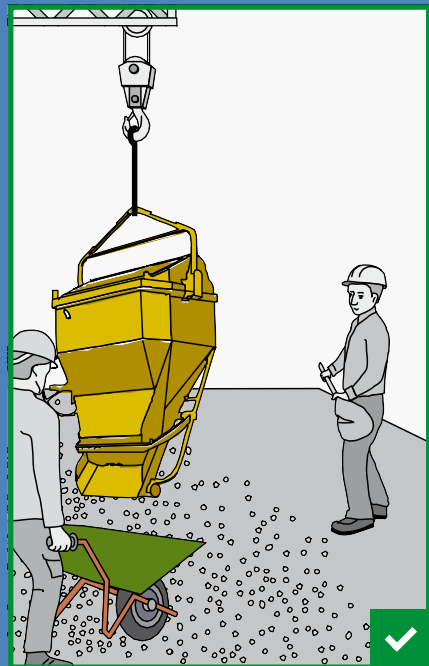
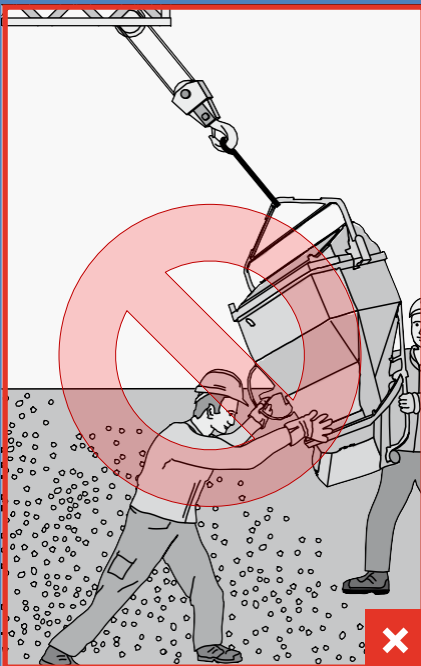
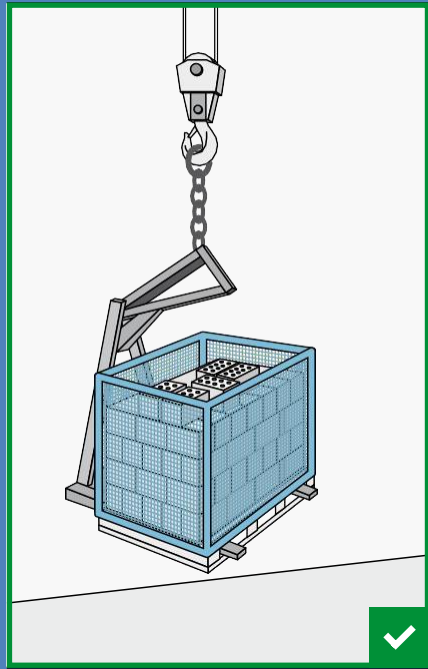
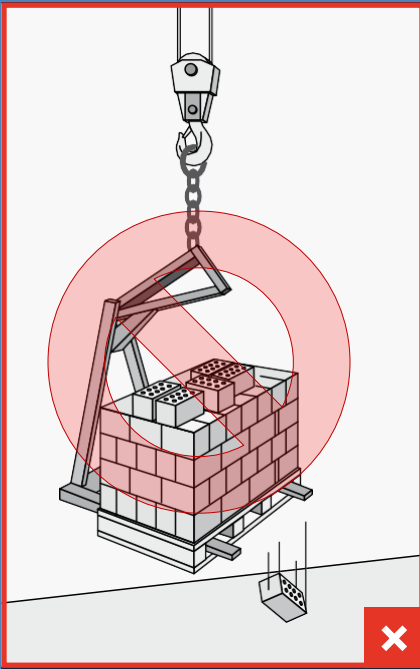

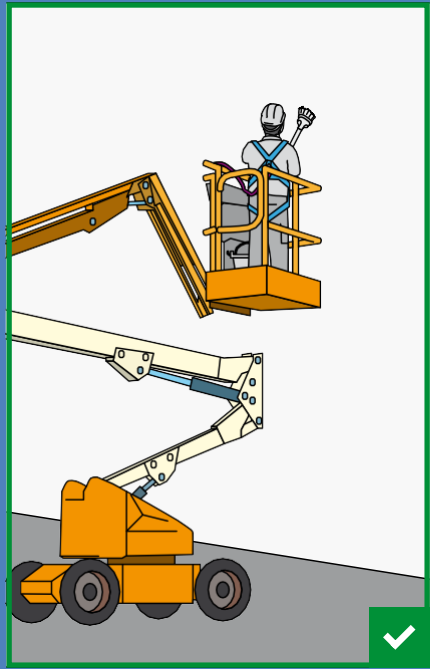
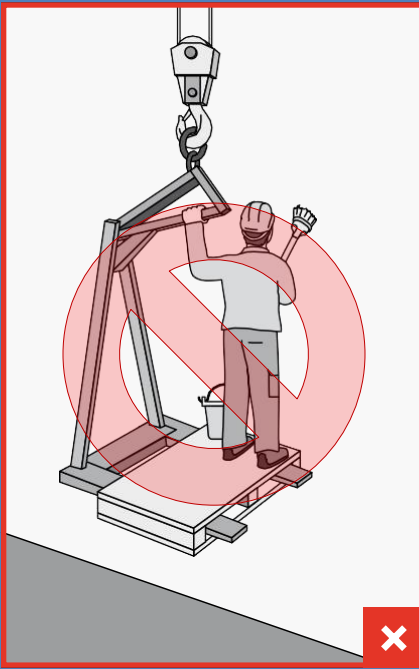

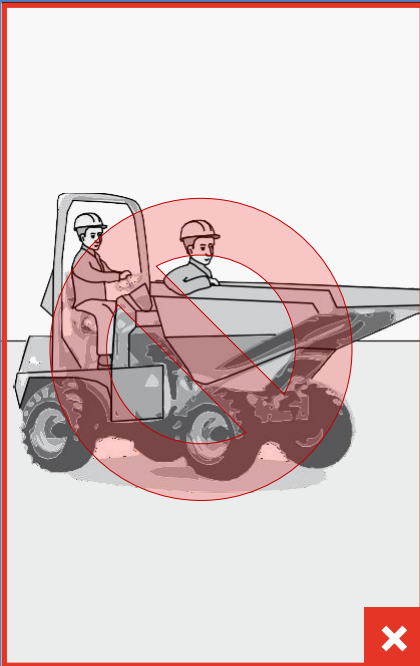
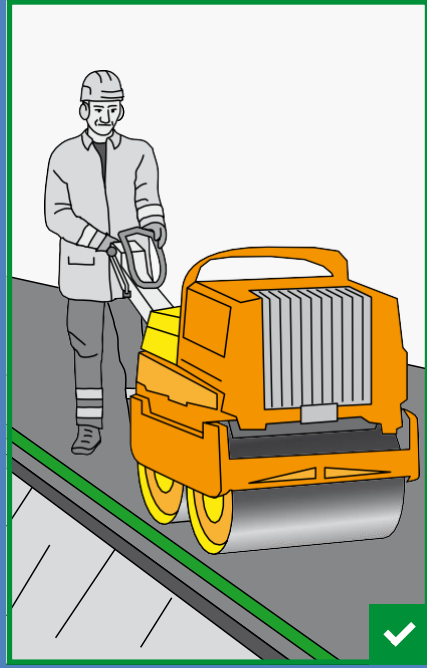

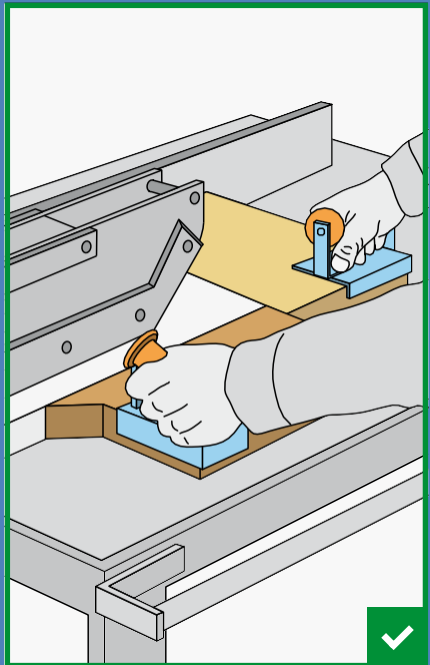
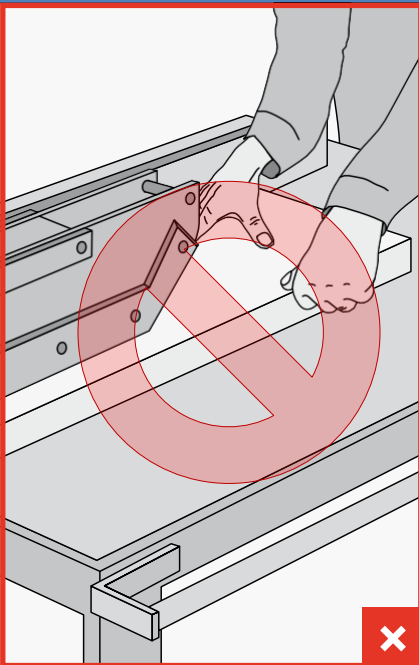
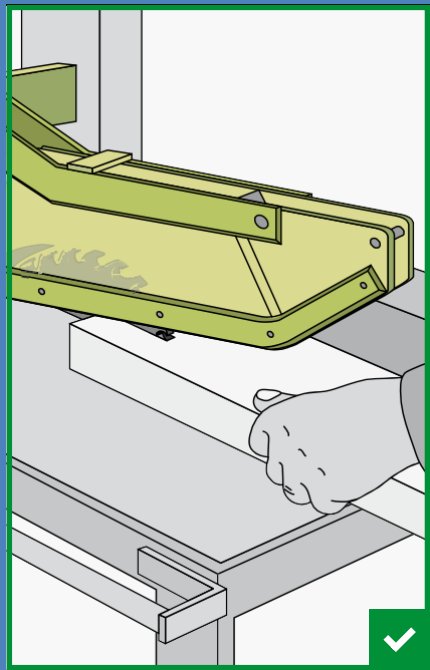
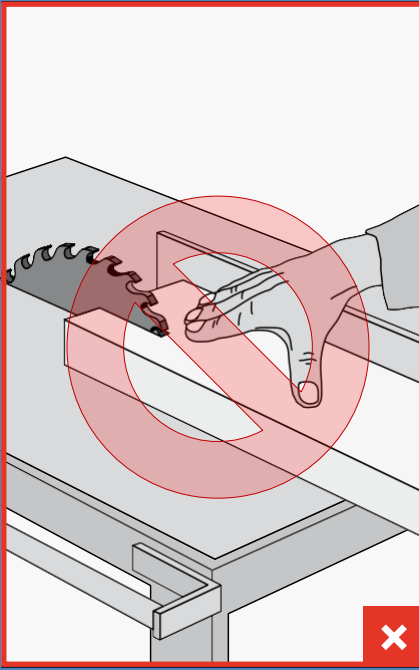

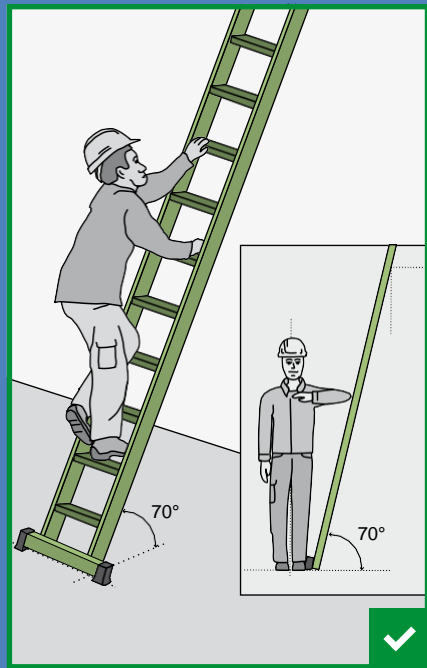
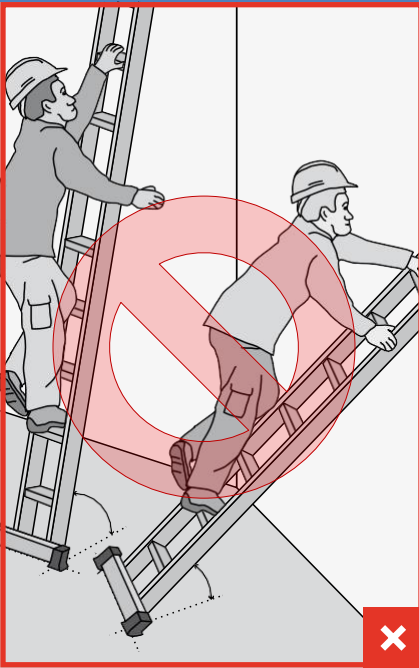

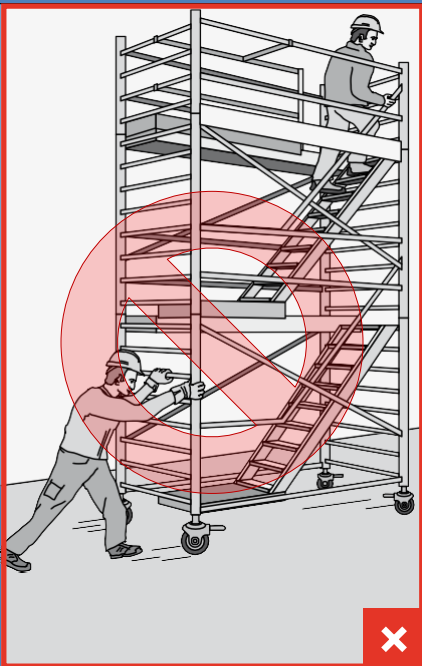
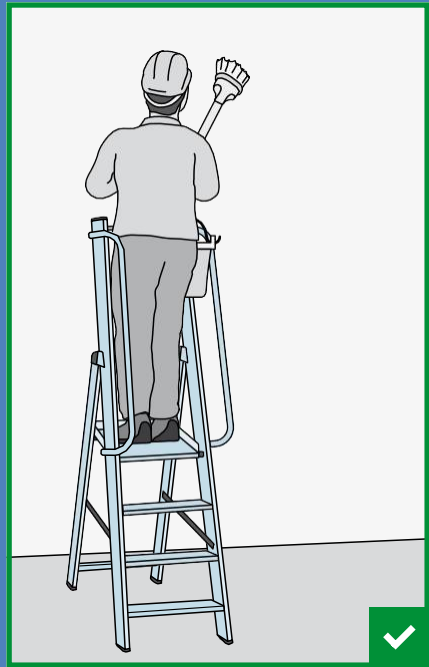
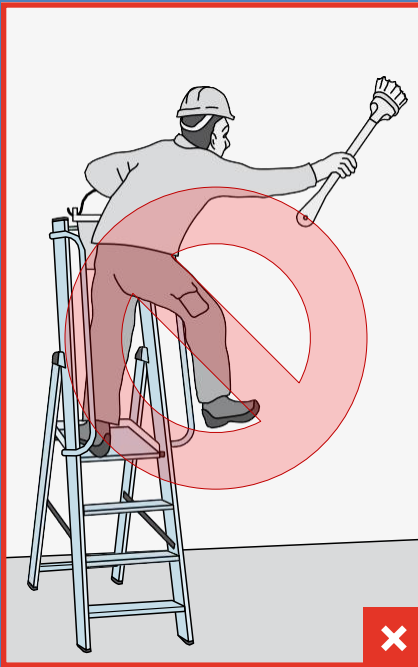

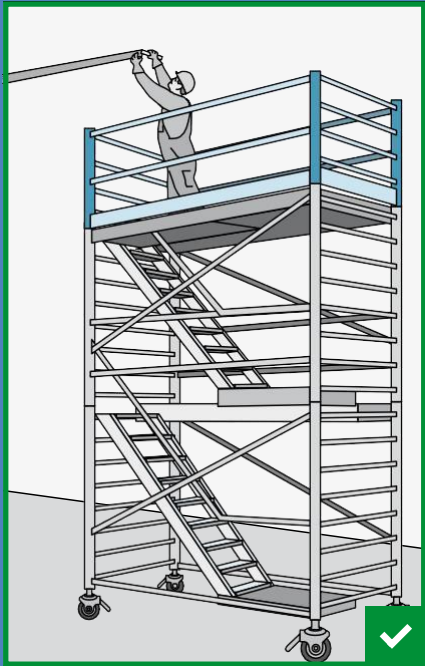
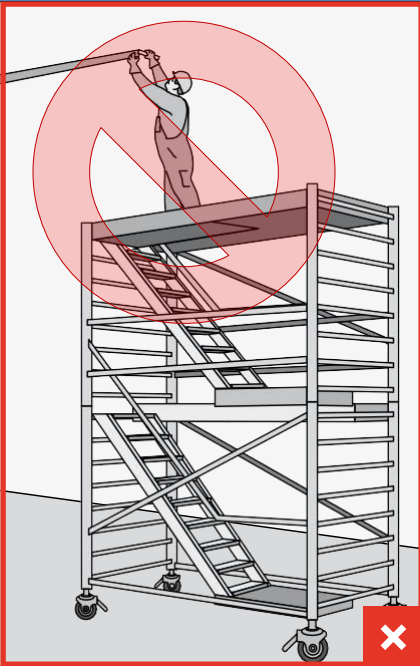
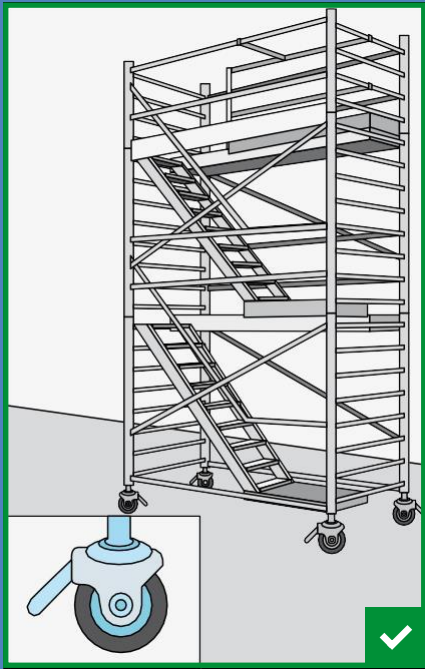
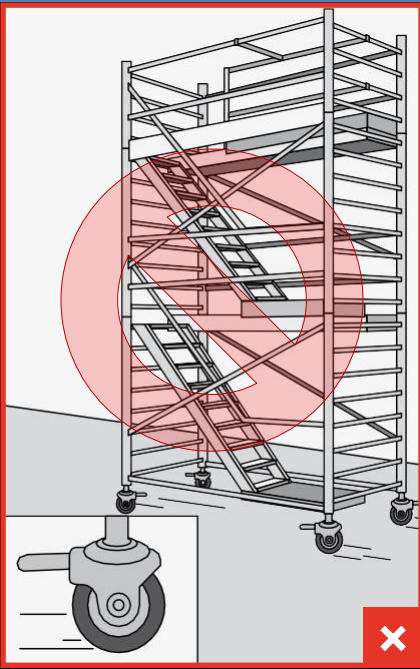

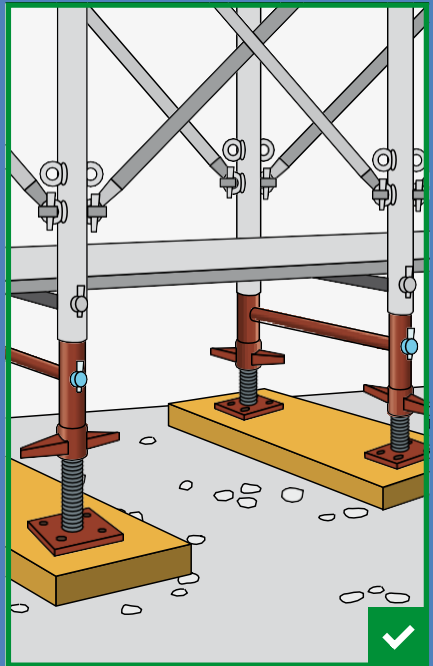
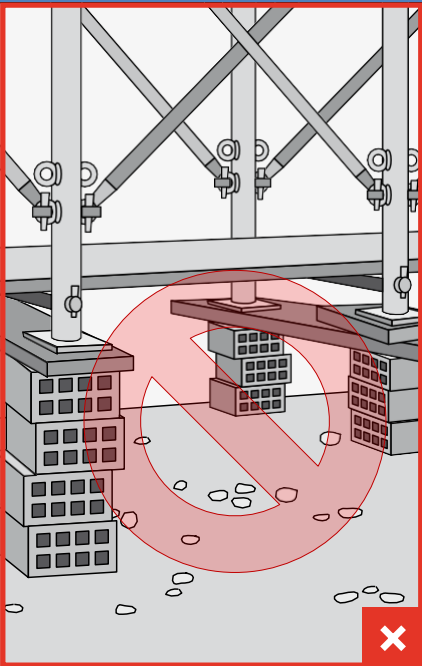
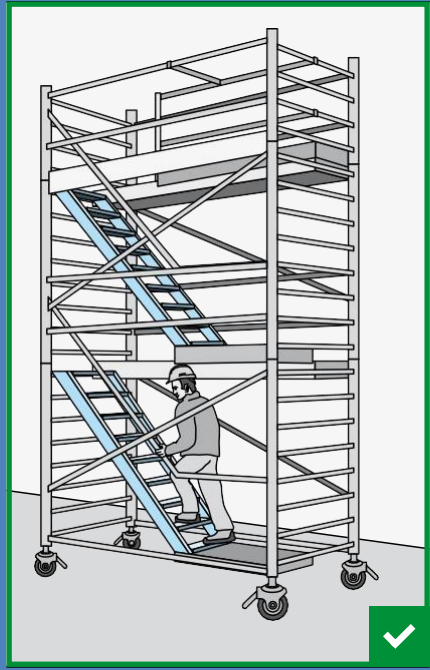
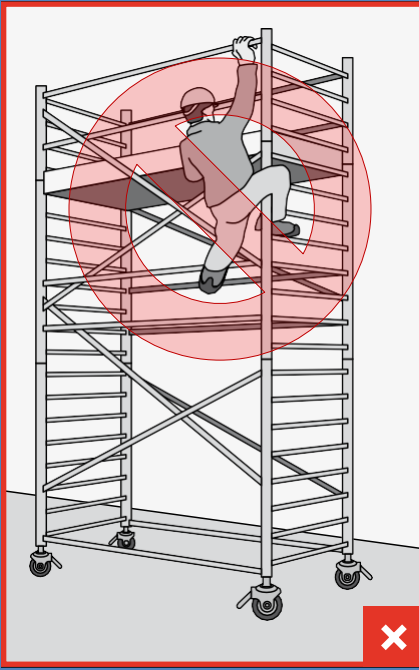

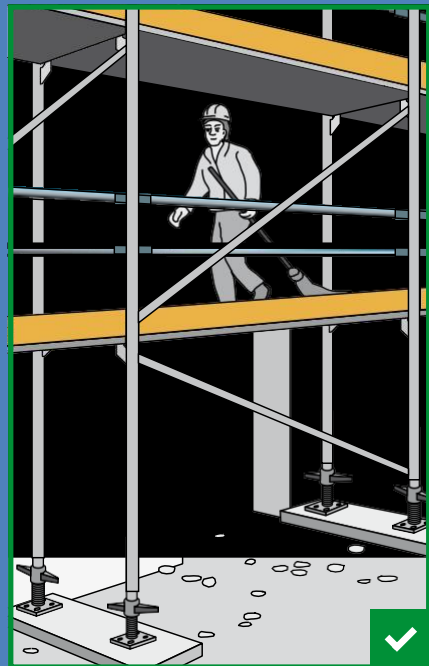
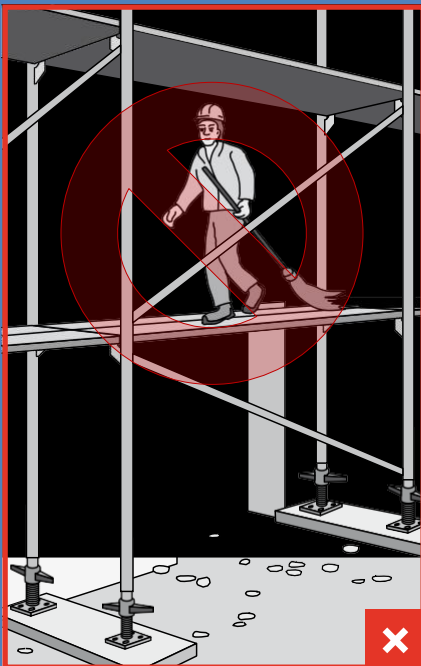
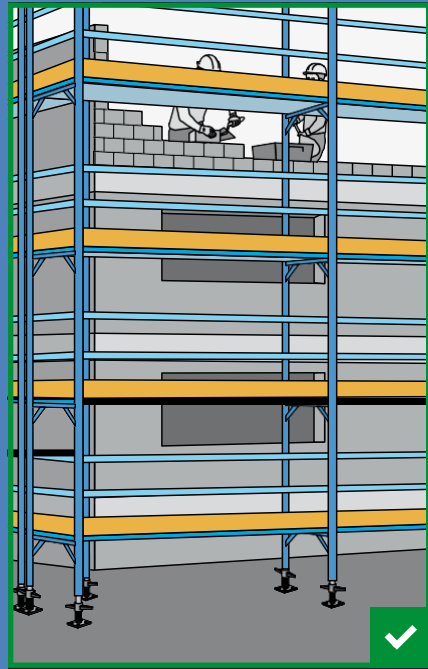
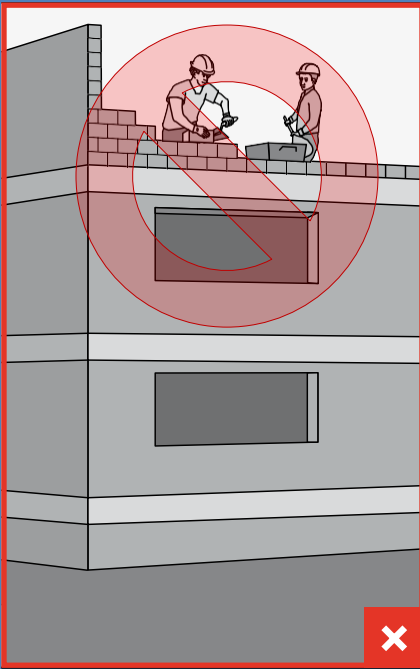

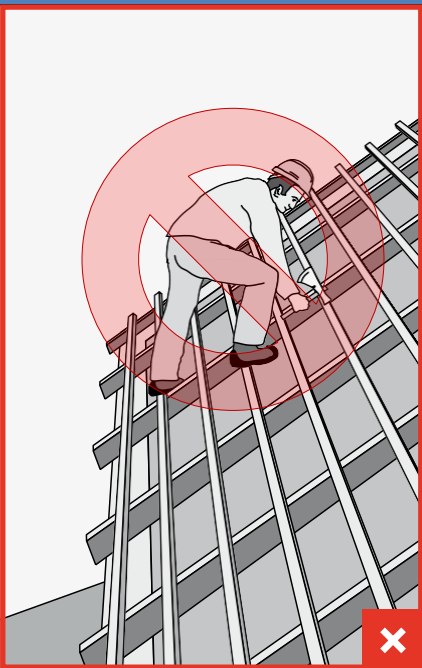
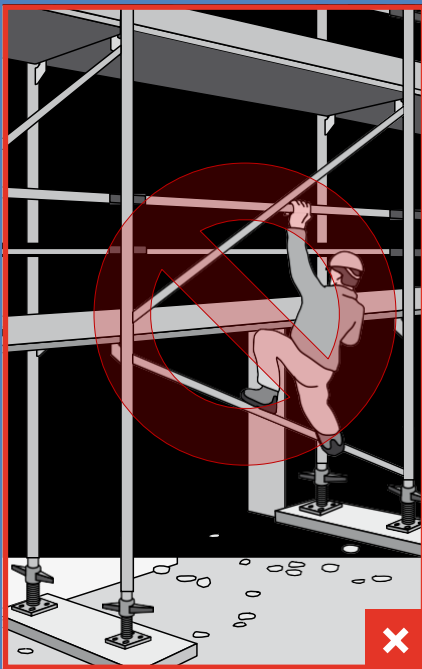

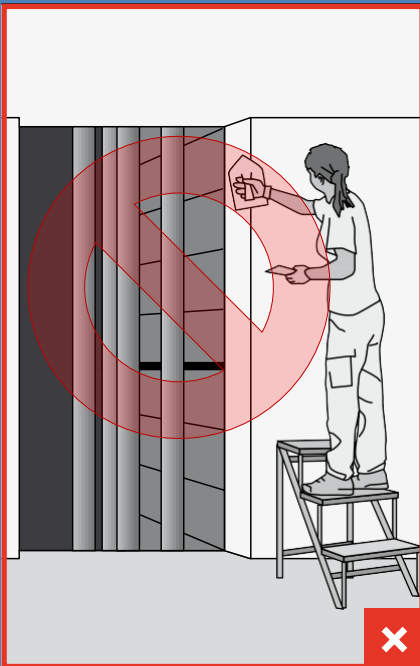
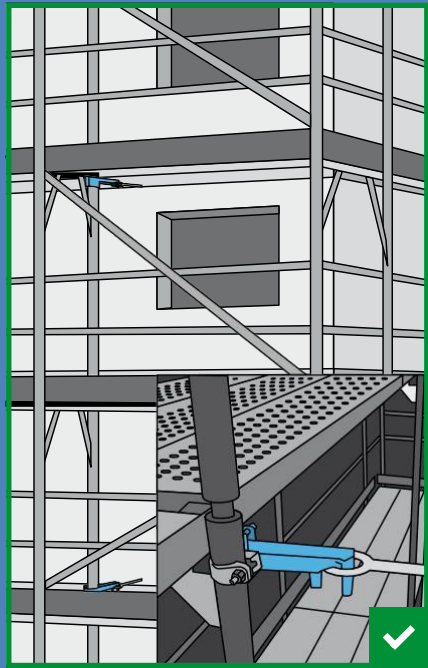
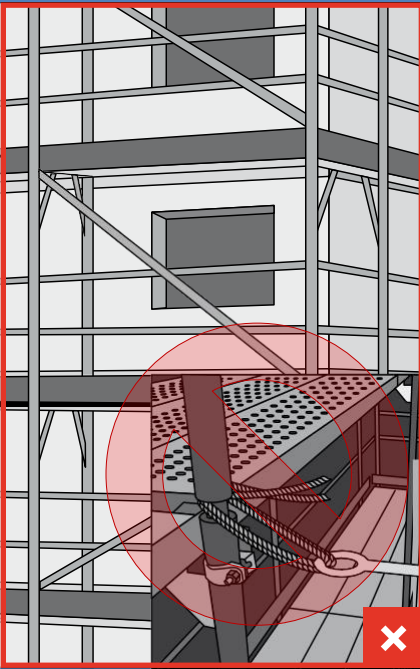

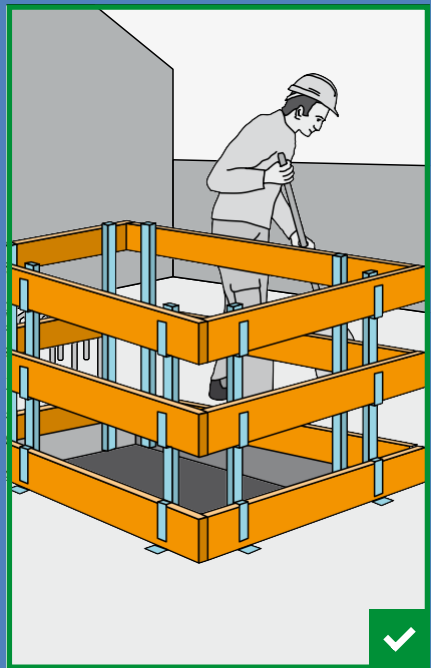
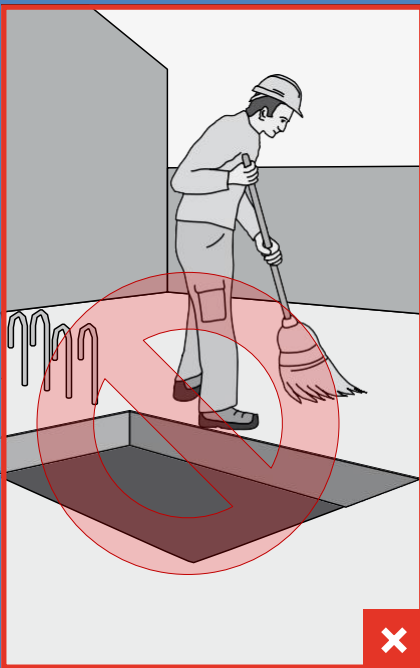

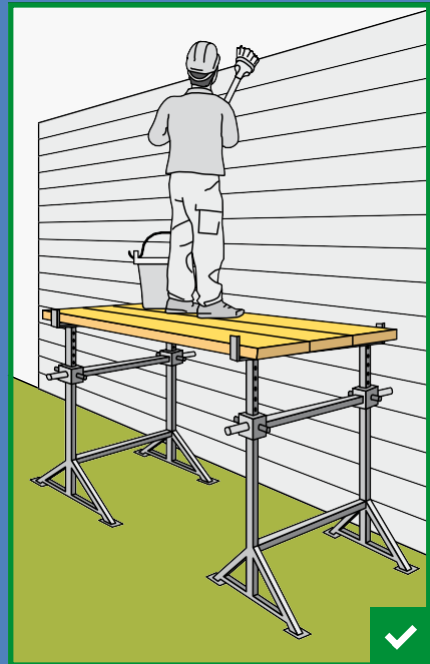
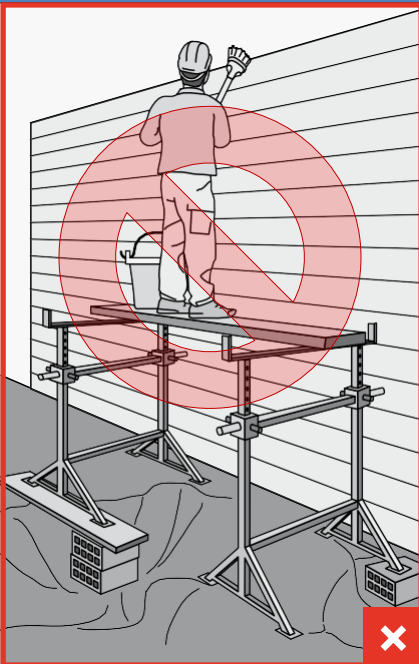
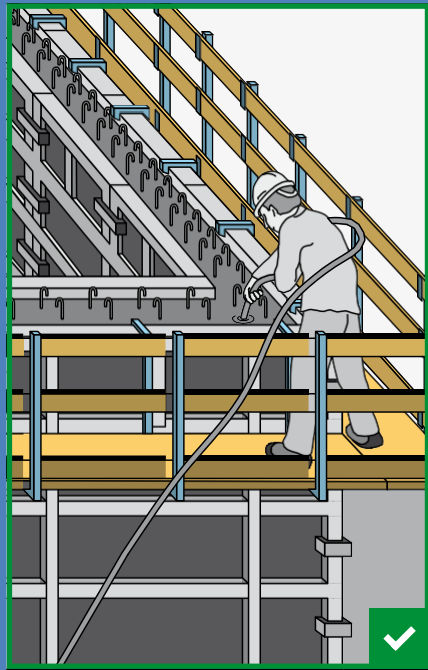
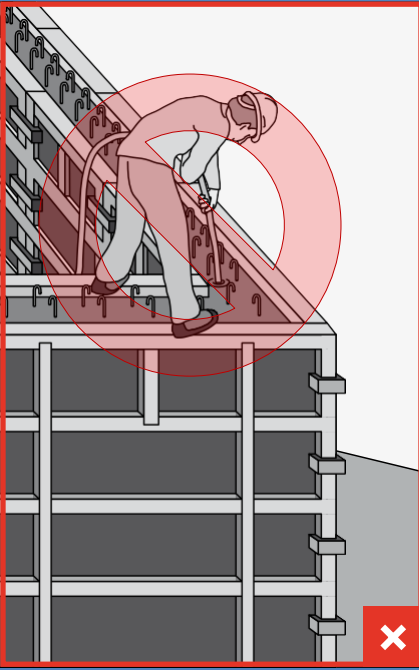

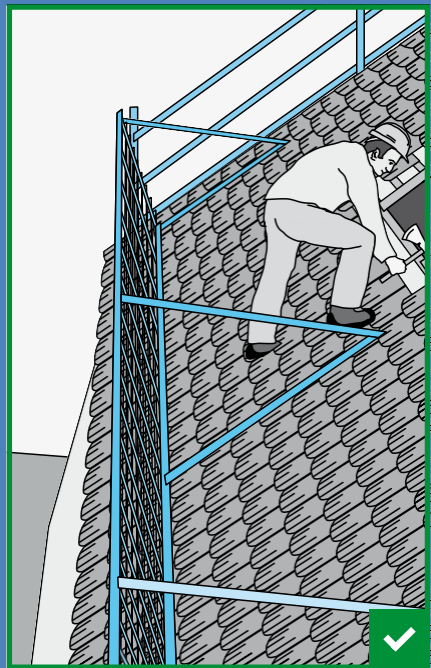
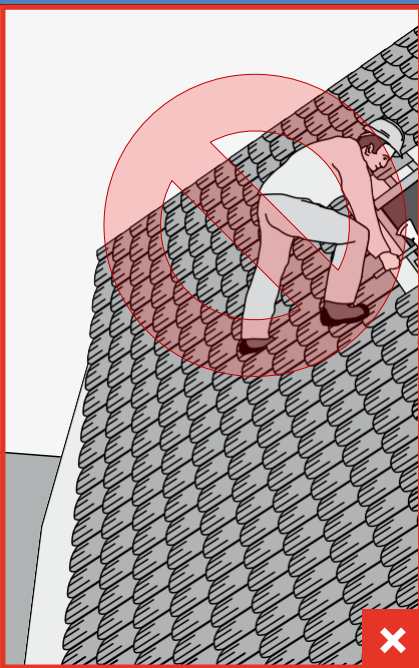
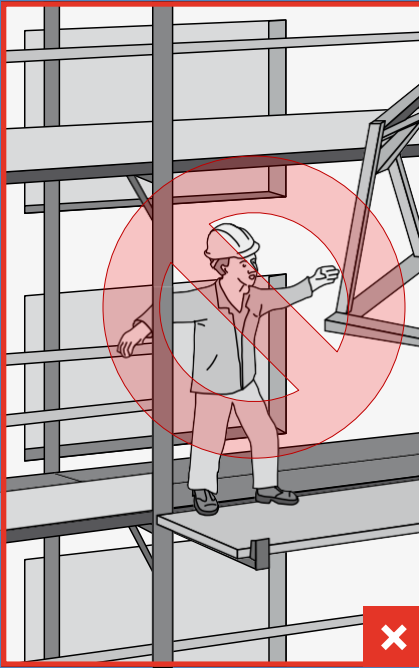

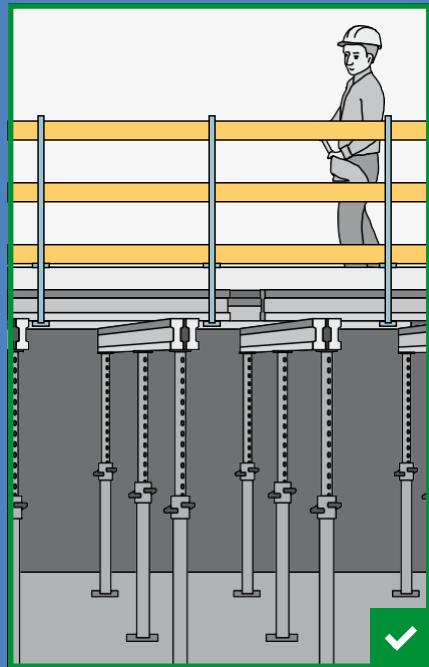
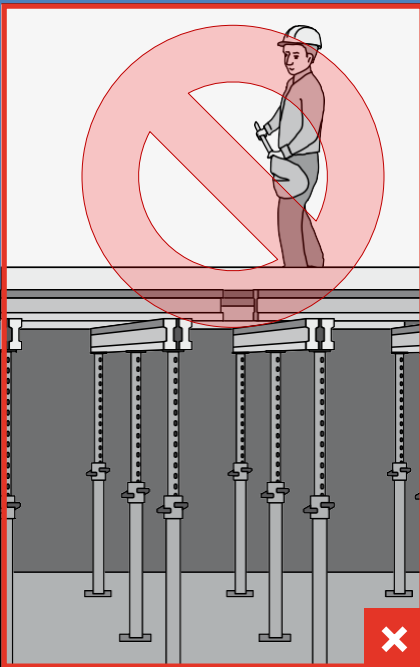
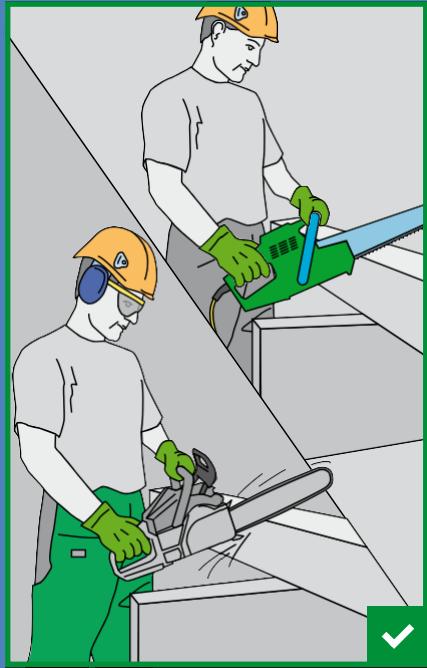

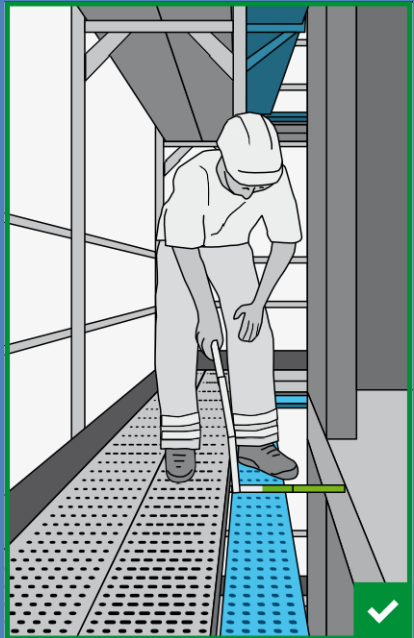
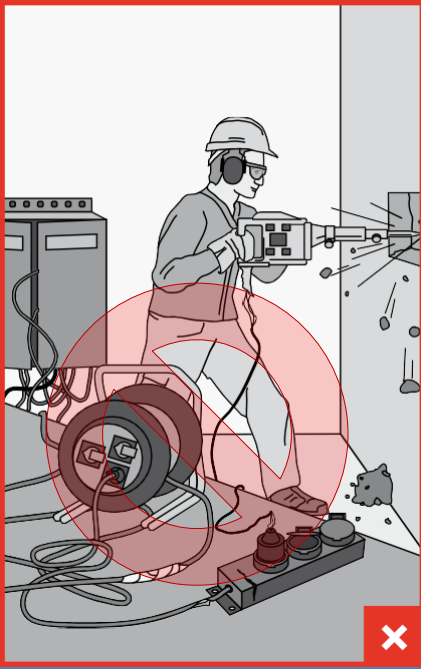

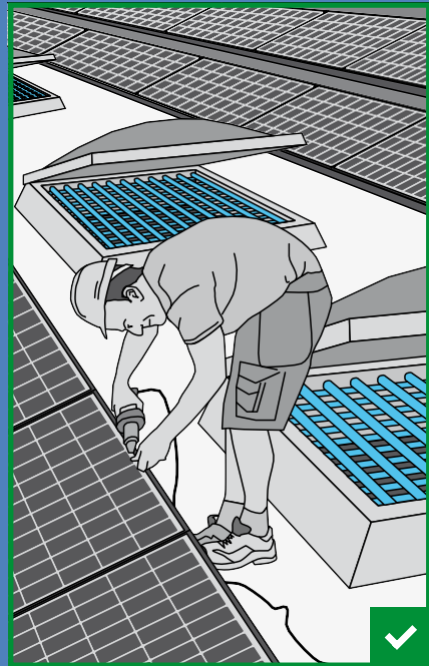
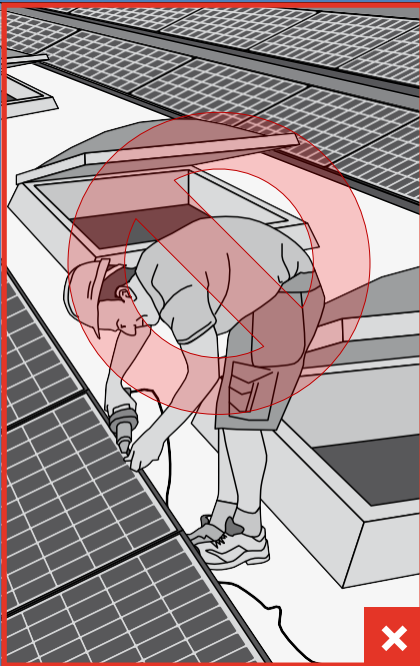
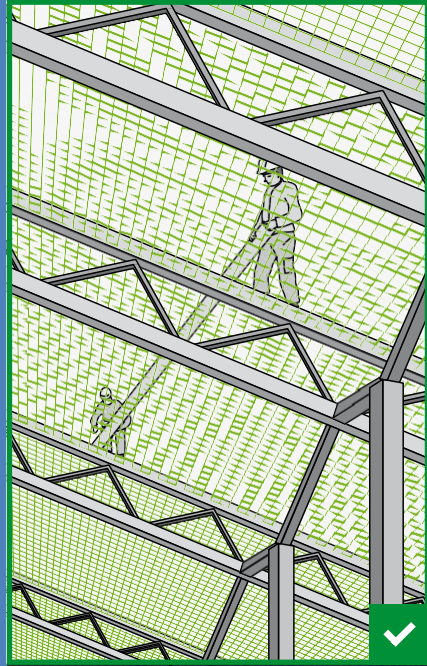
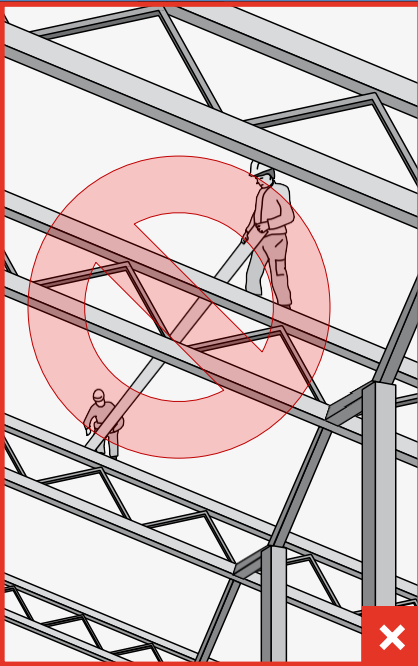

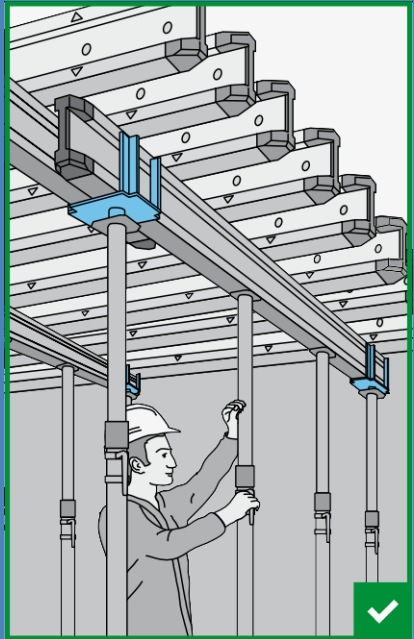
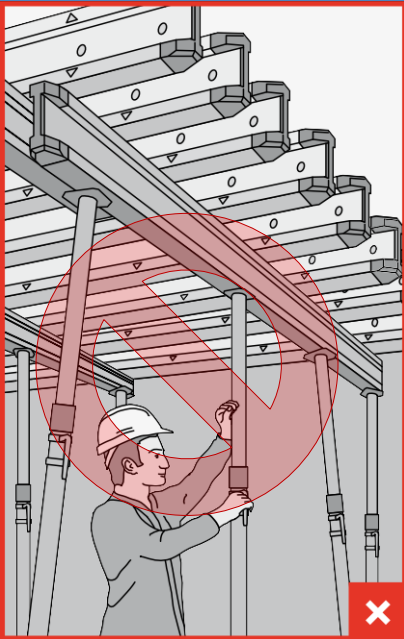
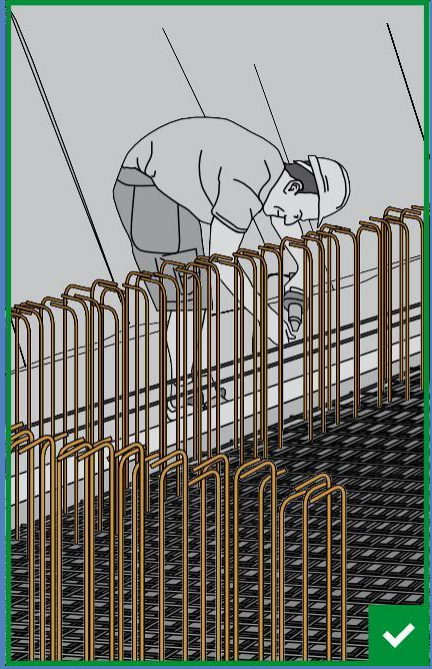
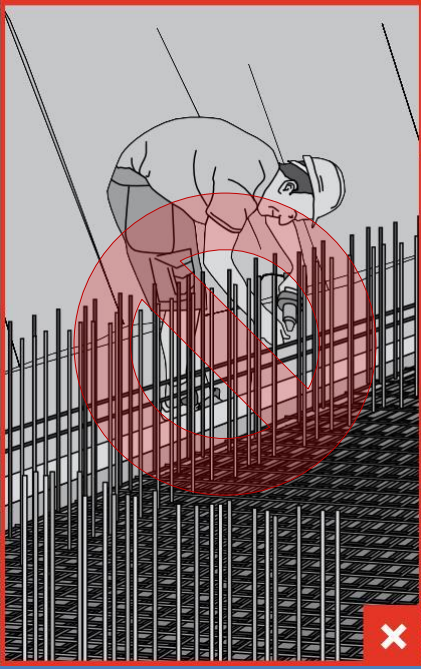

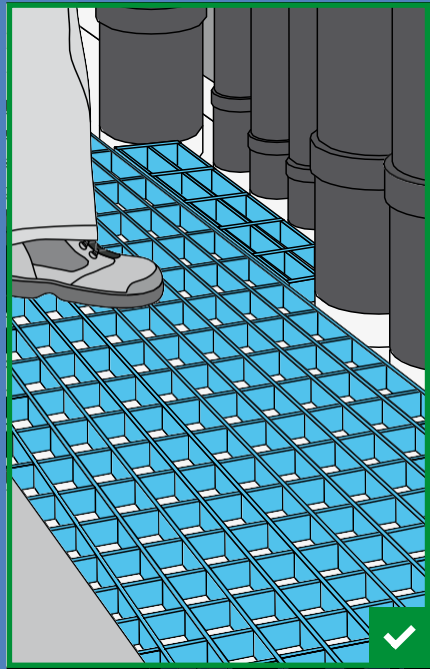
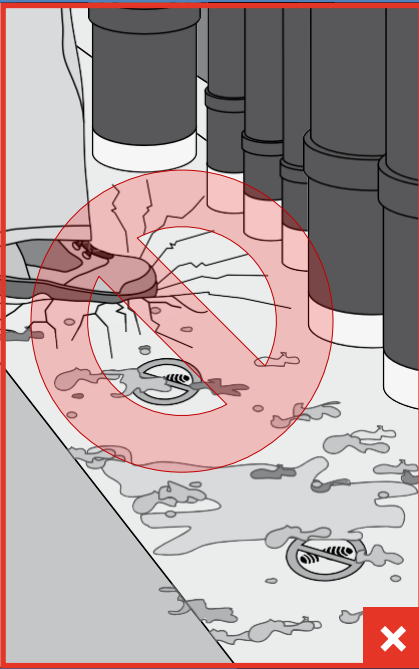

*Riproduzione autorizzata
Fonte: Suva - Casella postale, 6002
Lucerna Tel. 058 411 12 12
servizio.clienti@suva.ch*